



1 Form A  
Solid State Relay



## DESCRIPTION

The S106 is a bi-directional, single-pole, single-throw, normally open multipurpose relay. The circuit is composed of one LED on the input side which activates an optically coupled IC on the output - controlling the firing angle of two back-to-back SCRs. This circuit assures no false triggering under most adverse conditions, and a tight zero-volt window not exceeding 5V.

## FEATURES

- Zero-Volt Cross Switching
- High transient immunity
- 400V blocking voltage
- 0.8A maximum continuous current
- High input-to-output isolation
- Solid state reliability

## APPLICATIONS

- Valve control
- Solenoids
- Home appliances
- Metering equipment
- Heating elements

## OPTIONS/SUFFIXES\*

- -S Surface Mount Leadform Option
- -TR Tape and Reel Option

NOTE: Suffixes listed above are not included in marking on device for part number identification.

## ABSOLUTE MAXIMUM RATINGS\*

PARAMETER	UNIT	MIN	TYP	MAX
Storage Temperature	°C	-55		125
Operating Temperature	°C	-40		85
Continuous Input Current	mA			40
Transient Input Current	mA			400
Reverse Input Control Voltage	V	6		
Output Power Dissipation	mW			500

## SCHEMATIC DIAGRAM

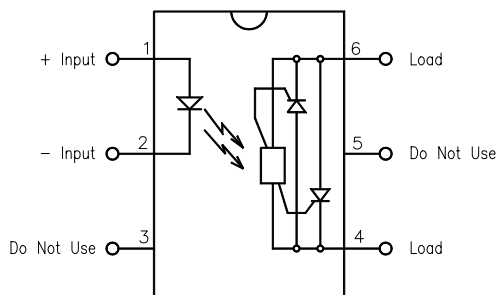

\*The values indicated are absolute stress ratings. Functional operation of the device is not implied at these or any conditions in excess of those defined in electrical characteristics section of this document. Exposure to Absolute Ratings may cause permanent damage to the device and may adversely affect reliability.

## APPROVALS

- UL / C-UL Approved, File # E90096
- BAPT Approved #608203

**ELECTRICAL CHARACTERISTICS - 25°C**

PARAMETER	UNIT	MIN	TYP	MAX	TEST CONDITIONS
<b>INPUT SPECIFICATIONS</b>					
LED Forward Voltage	V		1.2	1.5	If = 10mA
LED Reverse Voltage	V	6	12		Ir = 10uA
Turn-On Current (Resistive Load)	m A		5	6.5	Io = 0.8A
Turn-On Current (Inductive Load)	m A		10	12	Io = 300uA (AC)
Junction Capacitance	p F		5		Vf = 0V
<b>OUTPUT SPECIFICATIONS</b>					
Blocking Voltage	V	400			
Continuous Load Current	A			0.8	If = 6.5mA
Surge Current Rating	A			10	T = 16ms
Holding Current	m A			10	
On-Voltage	V			1.2	Io = 0.8A
Zero-Cross Turn-On Threshold Voltage	V			5	If = 5mA
Leakage Current	μ A		100	250	Vo = 250V
Thermal Resistance	° C / W		80		
Power Factor			0.3 <sup>1</sup>		See Note 1 below
Critical Rate of Rise (dV/dt)	V / μ s	400			
<b>COUPLED SPECIFICATIONS</b>					
Isolation Voltage	V	2500			T = 1 minute
-H Suffix	V	3750			T = 1 minute
Isolation Resistance	G Ω	100			
Coupled Capacitance	p F		6		

Note 1: Snubber circuits may be required for lower power factors

**PERFORMANCE DATA**

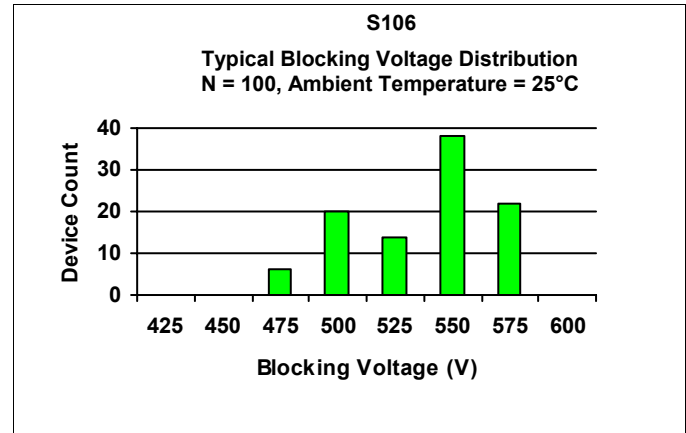
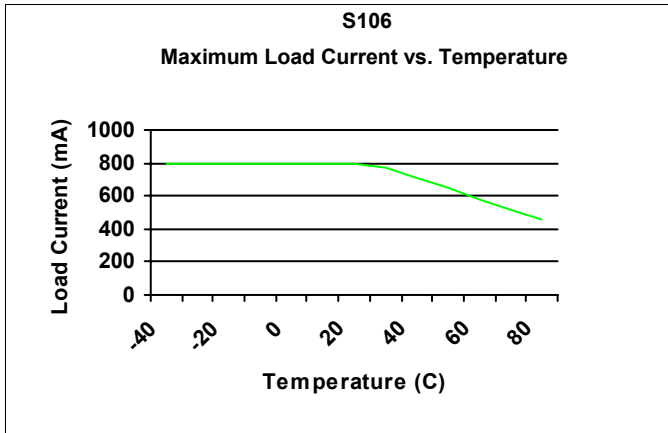

**ZERO-VOLT SWITCHING**

This solid state relay has been designed with a driver circuit that controls the operation of two back-to-back silicon controlled rectifiers (SCRs), each responsible for one half of the AC cycle. If an AC signal is examined, the turn on, turn off and zero-volt switching can be seen. Figure 1 shows a typical 60 Hz, 120Vac signal with a corresponding relay input signal:

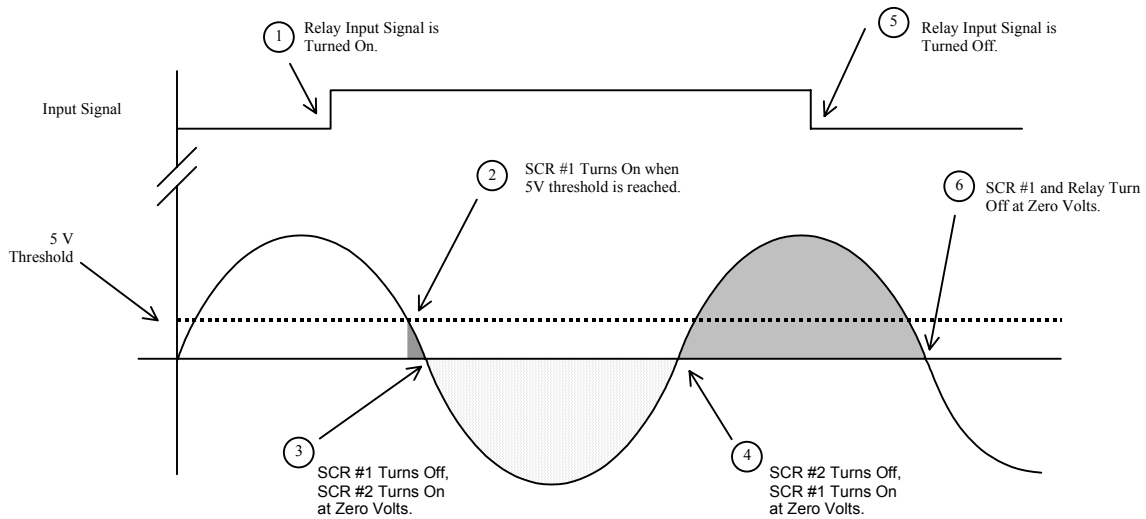
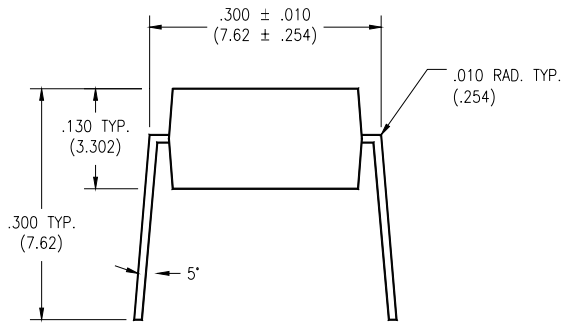

Figure 1 shows the sequence of zero-volt switching operation. At Stage 1, an input signal is applied to the relay. The relay will not turn on until the threshold voltage of 5V is reached. Once this point is reached (Stage 2), SCR #1 (designated as the SCR which controls positive AC voltage) turns on. However, SCR #1 only conducts for an instant, as the cycle quickly crosses zero. At this point (Stage 3), SCR #1 will turn off and SCR #2 (negative AC voltage) turns on. Likewise, at the next zero cross (Stage 4), SCR #2 will turn off and SCR #1 conducts again. Even though the input signal is terminated at Stage 5, the relay will continue to conduct (typical SCR behavior) until Stage 6, when SCR #1 crosses zero and ceases to conduct. Please note that turn on can likewise begin on the negative phase of the AC cycle with a -5V threshold, though only the positive phase is shown here.

**MECHANICAL DIMENSIONS**

**6 PIN DUAL IN-LINE PACKAGE**



**END VIEW**

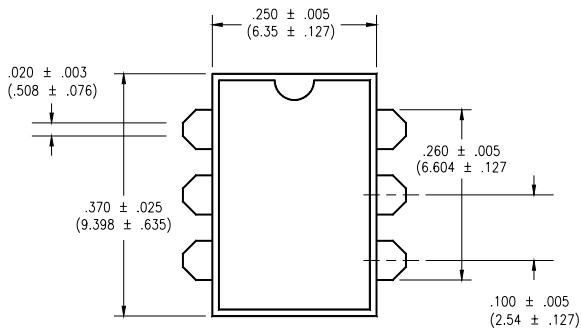

**TOP VIEW**

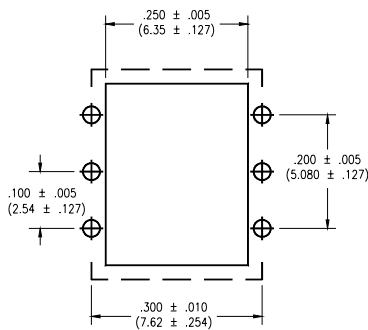

**BOTTOM VIEW/  
BOARD PATTERN**

**6 PIN SURFACE MOUNT DEVICE**

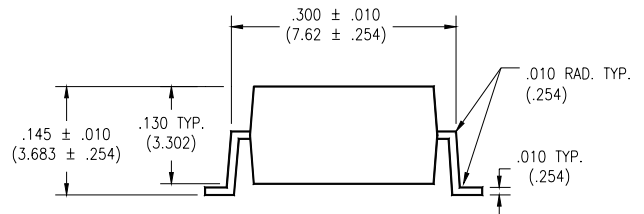

**END VIEW**

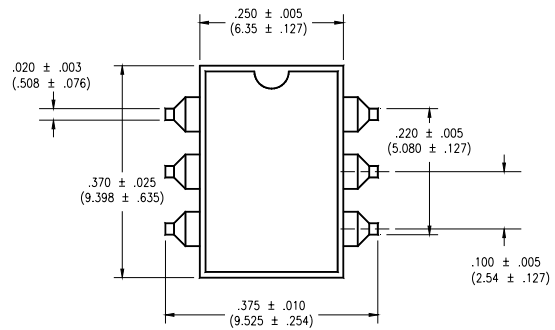

**TOP VIEW**

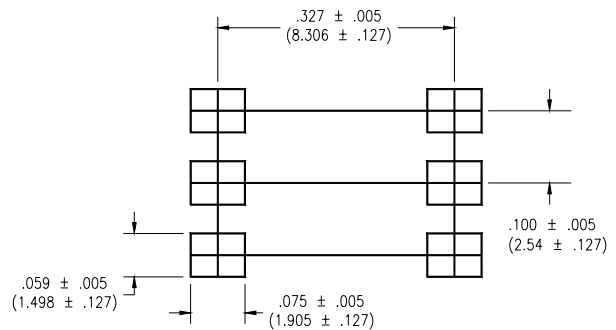

**BOTTOM VIEW/  
BOARD PATTERN**

## **DISCLAIMER**

---

*Solid State Optronics (SSO) makes no warranties or representations with regards to the completeness and accuracy of this document. SSO reserves the right to make changes to product description, specifications at any time without further notice. SSO shall not assume any liability arising out of the application or use of any product or circuit described herein. Neither circuit patent licenses nor indemnity are expressed or implied. Except as specified in SSO's Standard Terms & Conditions, SSO disclaims liability for consequential or other damage, and we make no other warranty, expressed or implied, including merchantability and fitness for particular use.*

## **LIFE SUPPORT POLICY**

---

*SSO does not authorize use of its devices in life support applications wherein failure or malfunction of a device may lead to personal injury or death. Users of SSO devices in life support applications assume all risks of such use and agree to indemnify SSO against any and all damages resulting from such use. Life support devices are defined as devices or systems which, (a) are intended for surgical implant into the body, or (b) support or sustain life, and (c) whose failure to perform when used properly in accordance with instructions for use can be reasonably expected to result in significant injury to the user, or (d) a critical component in any component of a life support device or system whose failure can be reasonably expected to cause failure of the life support device or system, or to affect its safety or effectiveness.*