



Zero-Volt Switching  
Triac Driver



## DESCRIPTION

The TD3042 consists of a single input LED optically coupled to a zero-volt crossing triac driver. The TD3042 provides high input-to-output isolation and is designed to drive high-powered triacs. Typical uses include interfacing logic level control signals to equipment powered from 110Vac and 220Vac lines.

## FEATURES

- Zero-volt switching
- 400V blocking voltage
- High input-to-output isolation (5kVrms MIN)
- Trigger current 10mA MAX
- High dV/dt (1kV/us MIN, 2kV/us TYP)

## OPTIONS/SUFFIXES\*

- -S Surface Mount Leadform Option (50 pcs / tube)
- -TR Tape and Reel Option (1000 pcs / reel)
- -V Signifies VDE approval
- -H 0.4" Lead Spacing (see mechanical dimension)

NOTE: Suffixes listed above are not included in marking on device for part number identification.

## SCHEMATIC DIAGRAM

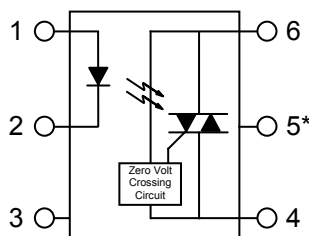

1. Anode
2. Cathode
3. N/C
4. MAIN Terminal
5. N/C\*
6. MAIN Terminal

\*DO NOT CONNECT  
Triac Substrate

## APPLICATIONS

- Home appliances
- Motor/ Drive controls
- Solid state relays
- Solenoid / Valve control
- Temperature Control

## ABSOLUTE MAXIMUM RATINGS\*

PARAMETER	UNIT	MIN	TYP	MAX
Storage Temperature	°C	-55		125
Operating Temperature	°C	-40		85
Continuous Input Current	mA			50
Transient Input Current	mA			400
Reverse Input Control Voltage	V			6
Total Power Dissipation	mW			330
Soldering Temperature (10s)	°C			260

\*The values indicated are absolute stress ratings. Functional operation of the device is not implied at these or any conditions in excess of those defined in electrical characteristics section of this document. Exposure to Absolute Ratings may cause permanent damage to the device and may adversely affect reliability.

## APPROVALS

- UL and C-UL Approved File # E201932
- VDE Approved, Lic # 40011225

**ELECTRICAL CHARACTERISTICS - 25°C**

PARAMETER	UNIT	MIN	TYP	MAX	TEST CONDITIONS
<b>INPUT SPECIFICATIONS</b>					
LED Forward Voltage	V		1.2	1.5	If = 10mA
LED Reverse Voltage	V	6	12		Ir = 10uA
Reverse Leakage Current	μ A			10	Vr = 4V
<b>OUTPUT SPECIFICATIONS</b>					
Blocking Voltage	V	400			Io = 1uA
Peak Blocking Current	n A		60	500	Vdm = Rated
On-state Voltage	V		1.8	3	I <sub>tm</sub> = 100mA
Critical Rate of Rise (See Note 1 below)	V / μ s	1,000	2,000		If = 0mA
<b>COUPLED SPECIFICATIONS</b>					
Isolation Voltage	V	5000			T = 1 minute
Trigger Current (See Note 2 below)	m A			10	Main terminal voltage = 3V
Inhibit Voltage	V		5	20	If = 5mA
Isolation Resistance	G Ω	50			DC 500V
Holding Current	μ A		100		
Leakage Current	μ A			1	If = Rated, Vdm = Rated, Off State

Note 1: This is for static dV/dt. Test circuit below

Note 2: Resistive load. For inductive loads, higher drive current is recommended.

**STATIC dV/dt TEST CIRCUIT**

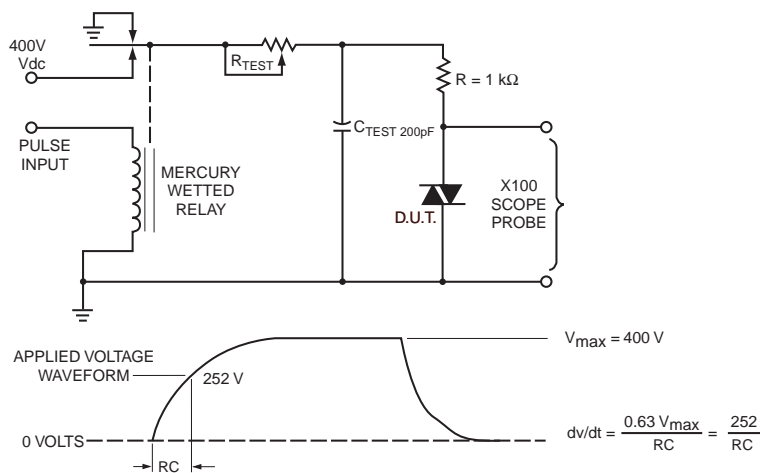

**PERFORMANCE DATA**

**Fig.1 On-State Characteristics**

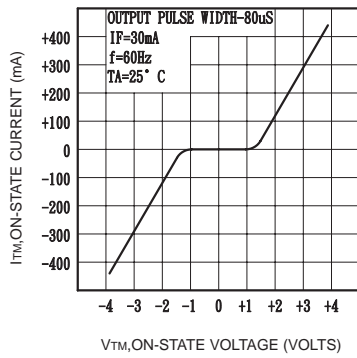

**Fig.2 Inhibit Voltage versus Temperature**

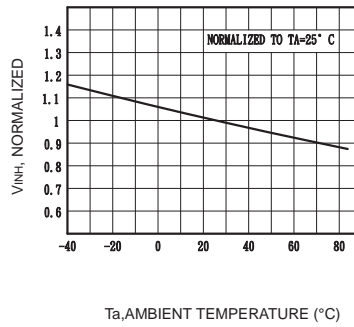

**Fig.3 Leakage with LED Off versus Temperature**

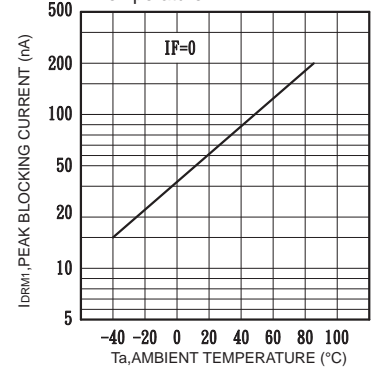

**Fig.4  $I_{DRM2}$  Leakage in Inhibit State versus Temperature**

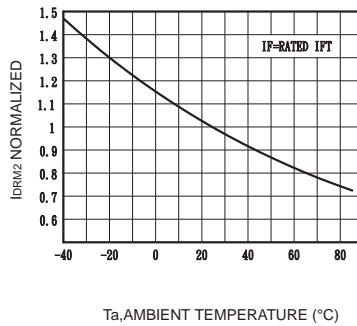

**Fig.5 Trigger Current versus Temperature**

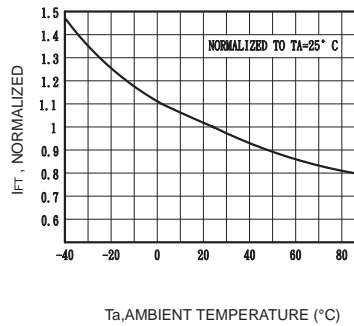

**MECHANICAL DIMENSIONS**

**6 PIN DUAL IN-LINE PACKAGE (Through Hole)**

**6 PIN SURFACE MOUNT DEVICE (SMD)**

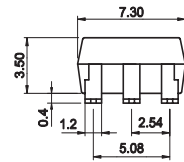
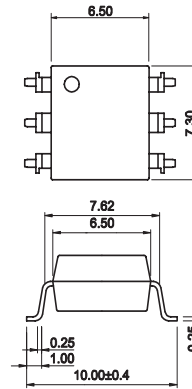
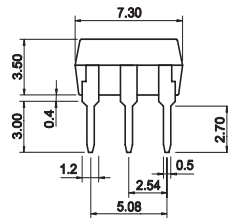
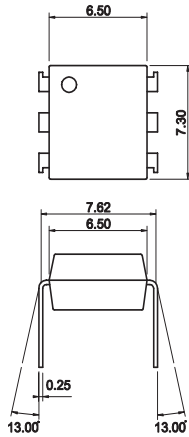

**-H Suffix 0.4" Lead Spacing**

TOLERANCE :+ 0.25mm

**Unit in (mm)**

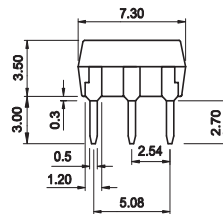
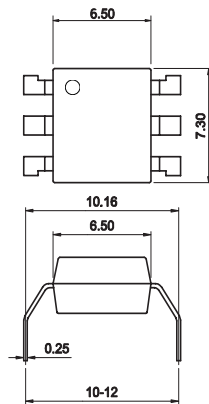

---

## DISCLAIMER

*Solid State Optronics (SSO) makes no warranties or representations with regards to the completeness and accuracy of this document. SSO reserves the right to make changes to product description, specifications at any time without further notice. SSO shall not assume any liability arising out of the application or use of any product or circuit described herein. Neither circuit patent licenses nor indemnity are expressed or implied. Except as specified in SSO's Standard Terms & Conditions, SSO disclaims liability for consequential or other damage, and we make no other warranty, expressed or implied, including merchantability and fitness for particular use.*

---

## LIFE SUPPORT POLICY

*SSO does not authorize use of its devices in life support applications wherein failure or malfunction of a device may lead to personal injury or death. Users of SSO devices in life support applications assume all risks of such use and agree to indemnify SSO against any and all damages resulting from such use. Life support devices are defined as devices or systems which, (a) are intended for surgical implant into the body, or (b) support or sustain life, and (c) whose failure to perform when used properly in accordance with instructions for use can be reasonably expected to result in significant injury to the user, or (d) a critical component in any component of a life support device or system whose failure can be reasonably expected to cause failure of the life support device or system, or to affect its safety or effectiveness.*